



**HAL**  
open science

# Elaboration and characterization of Ni/BaTiO<sub>3</sub> Functionally Graded Piezoelectric Material for active vibration control applications

Julie Cédelle, Damien Bregiroux, Johann J. Petit, Isabelle Bruant, Luc  
Davenne

► **To cite this version:**

Julie Cédelle, Damien Bregiroux, Johann J. Petit, Isabelle Bruant, Luc Davenne. Elaboration and characterization of Ni/BaTiO<sub>3</sub> Functionally Graded Piezoelectric Material for active vibration control applications. 24th International Conference on Advanced Materials Technology, Oct 2019, Rome, Italy. . hal-03117341

**HAL Id: hal-03117341**

**<https://hal.parisnanterre.fr/hal-03117341>**

Submitted on 21 Jan 2021

**HAL** is a multi-disciplinary open access archive for the deposit and dissemination of scientific research documents, whether they are published or not. The documents may come from teaching and research institutions in France or abroad, or from public or private research centers.

L'archive ouverte pluridisciplinaire **HAL**, est destinée au dépôt et à la diffusion de documents scientifiques de niveau recherche, publiés ou non, émanant des établissements d'enseignement et de recherche français ou étrangers, des laboratoires publics ou privés.

Julie Cédelle<sup>1</sup>, Damien Bregiroux<sup>2</sup>, Johann Petit<sup>1</sup>, Isabelle Bruant<sup>1</sup>, Luc Davenne<sup>1</sup>

1 LEME, UPL, Université Paris Nanterre, Ville d'Avray, France.  
2 LCMCP, Sorbonne Université, Paris, France.

## Context of the study : the active vibration control of smart FGPM structures.

The FGPM structures are new composite, designed to achieve a functional performance with mechanical (m) and piezoelectric (p) properties that gradually evolve along the transversal direction. Due to the piezoelectric effects, the vibrations of light-weight FGPM structures can be actively damped with a controller.

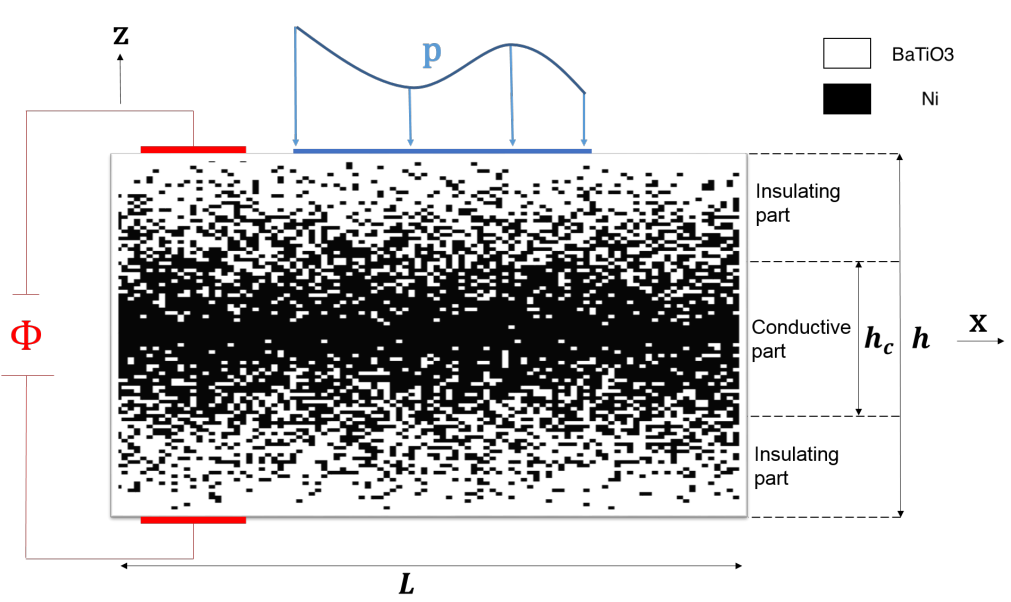

Homogenization law used for simulations: [1]

$$V^{(m)}(z) = 1 - \frac{2|z|}{h}, z \in \left[-\frac{h}{2}, \frac{h}{2}\right]$$

$$P(z) = (P^{(m)} - P^{(p)})(V^{(m)}(z))^k + P^{(p)} \quad (\text{eq 1})$$

$P(z)$ : effective material properties  
 $k$ : fraction index

The drawbacks of these simulations are the use of a conceptual model. Does this model reflect the real behavior of FGPM?

Main topics:

- The elaboration of Ni/BaTiO<sub>3</sub> FGPM

- The experimental characterization of material properties.

Numerical simulations of FGPM beam active control, with

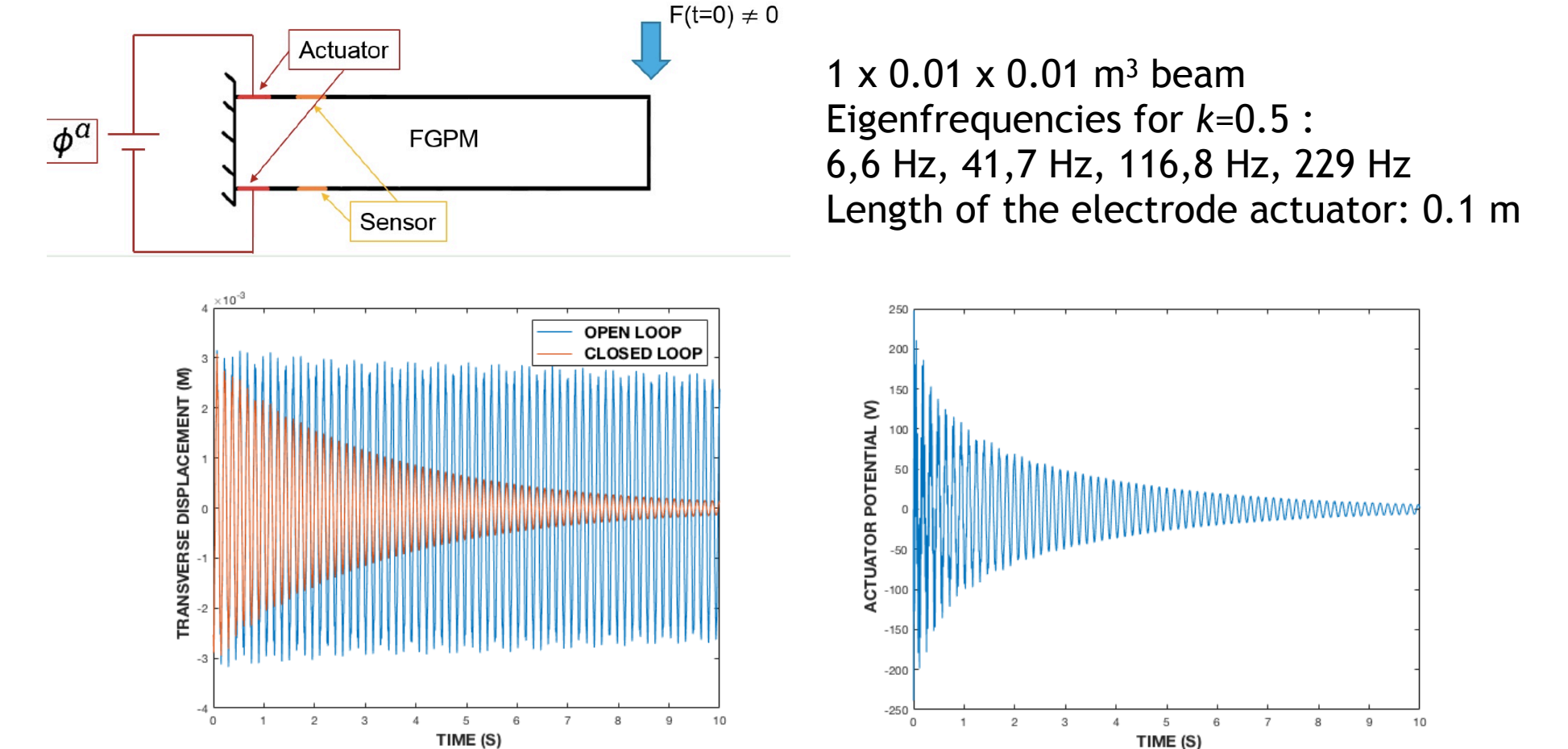

The simulations of the active control using LQR controller show the efficiency of this new concept [2]. Here, in the case of a release test, the vibrations are vanished in less than 10 s.

## Elaboration of FGPM Ni/BaTiO<sub>3</sub> pellet:

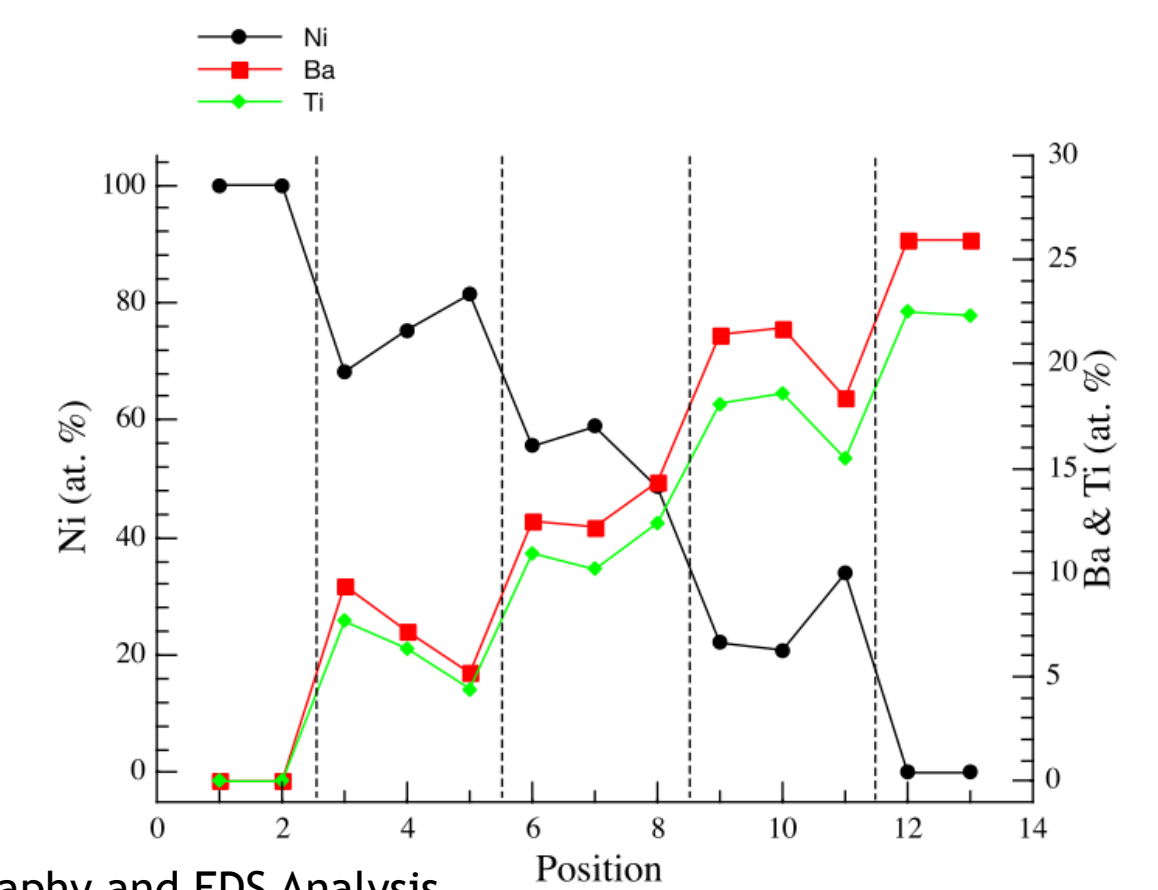
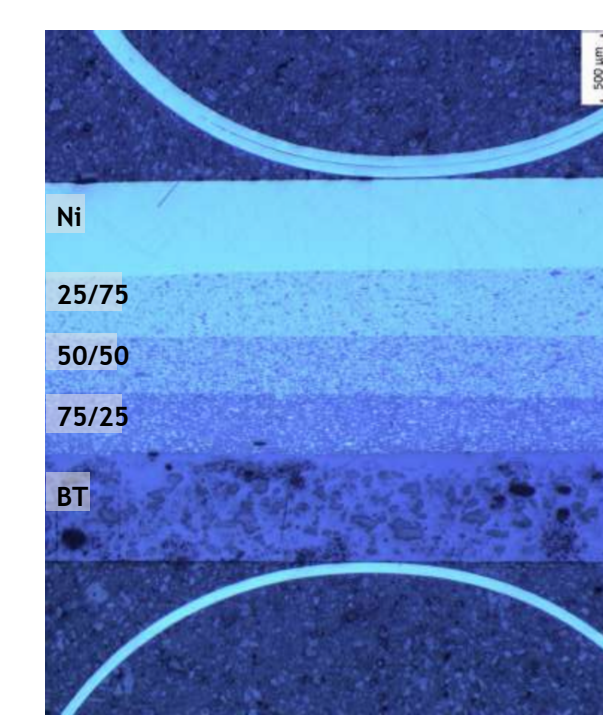
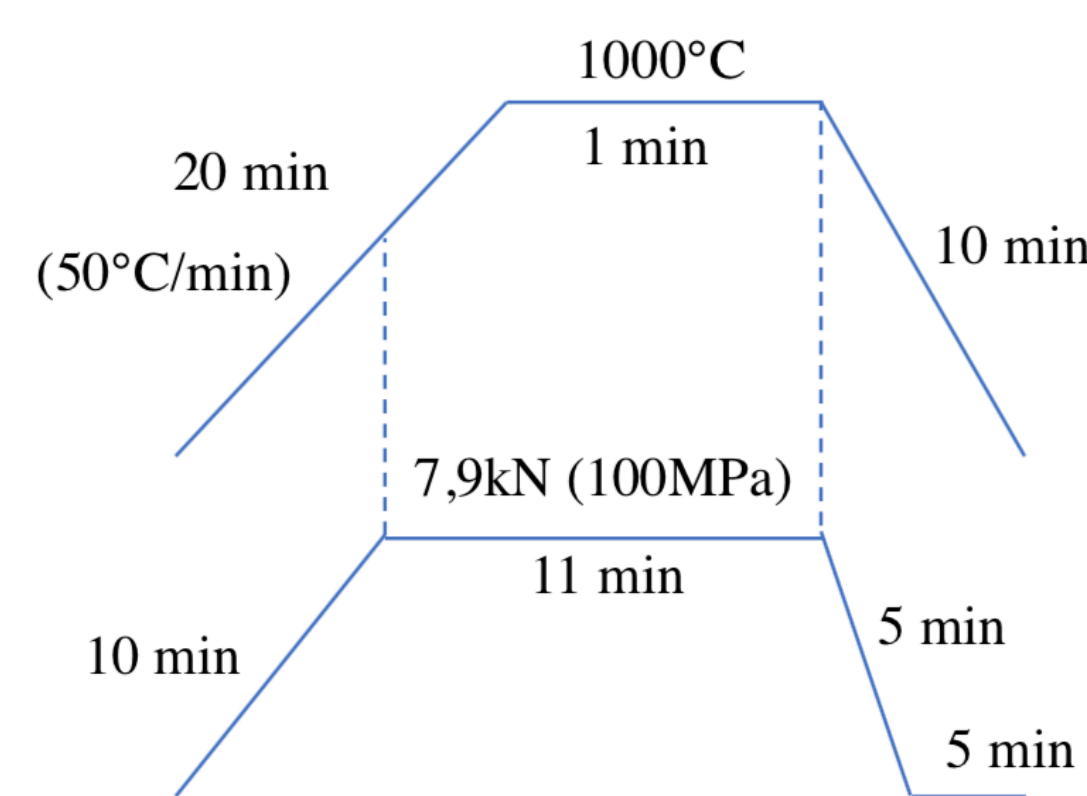
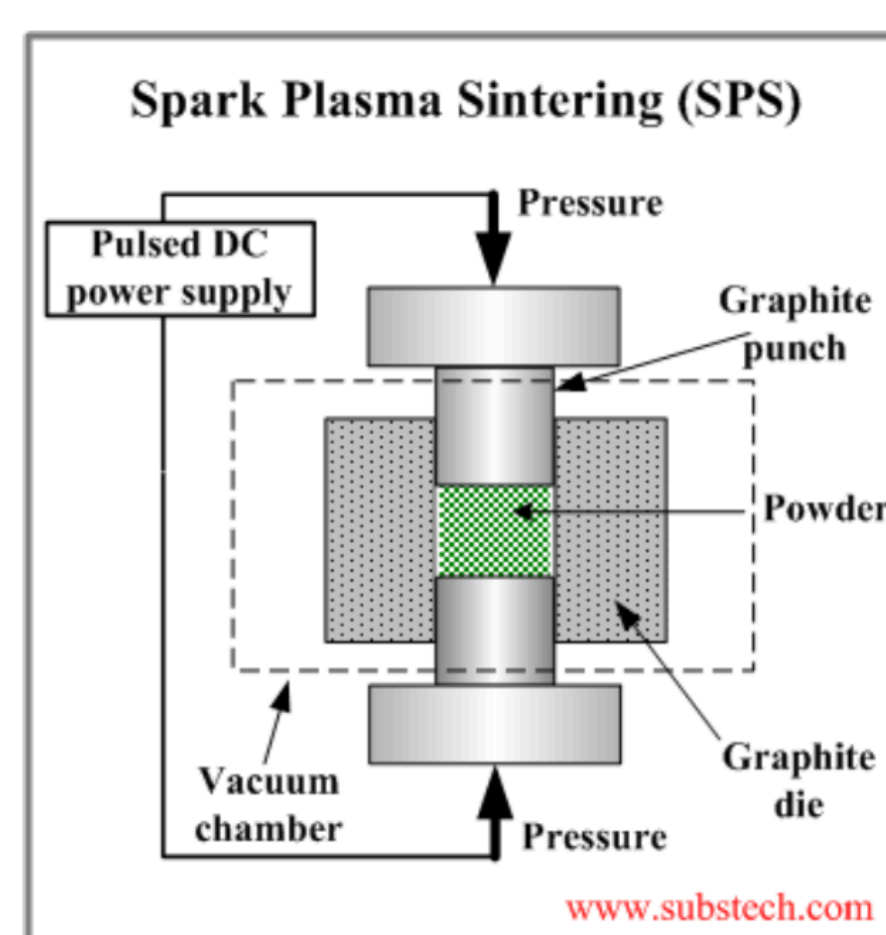
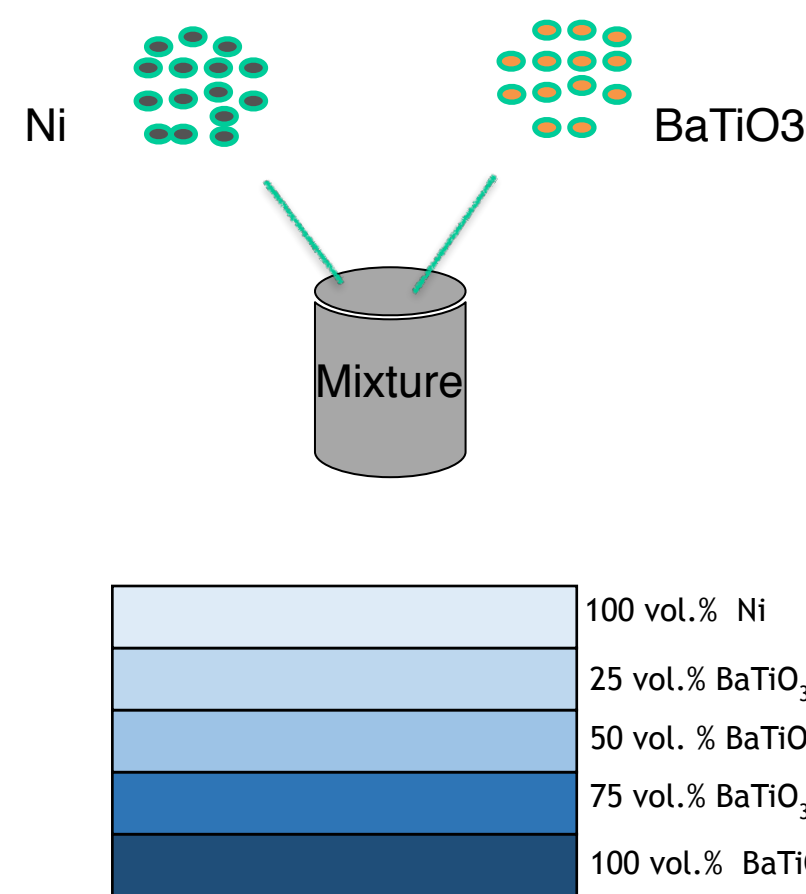

FGM sample micrography and EDS Analysis

Ni/BaTiO<sub>3</sub> FGPM pellet has been elaborated by the Spark Plasma Sintering technique (Dr Sinter-Lab SPS-515S, SPS Sintex Inc.). SPS sintering consists of heating the sample very quickly while applying a uniaxial charge. Thus, it is possible to densify the material in very short time thus limiting both grain growing and the interdiffusion of different chemical species. We propose to sinter together layers of mixture of ceramic powder/metal with compositions ranging from 100% ceramic to 100% metal. Powders were sintered in a 15 mm diameter graphite die with a constant applied pressure of 100 MPa. The heating rate was fixed to 50°C.min<sup>-1</sup>. The cooling rate was around 100°C.min<sup>-1</sup>.

## Experimental Characterization of materials properties $P(z)$ :

A first study is conducted to define the thermal and mechanical properties  $P(z)$ . Five powder mixtures have been used and sintered (in vol.%): 100% Ni, 75% Ni/25% BaTiO<sub>3</sub>, 50% Ni/50% BaTiO<sub>3</sub>, 25%Ni/75% BaTiO<sub>3</sub> and 100% BaTiO. Different pellets (5 mm thickness, 15 mm diameter) were obtained in order to characterize independently and model the continuous nature of a smart FGPM.

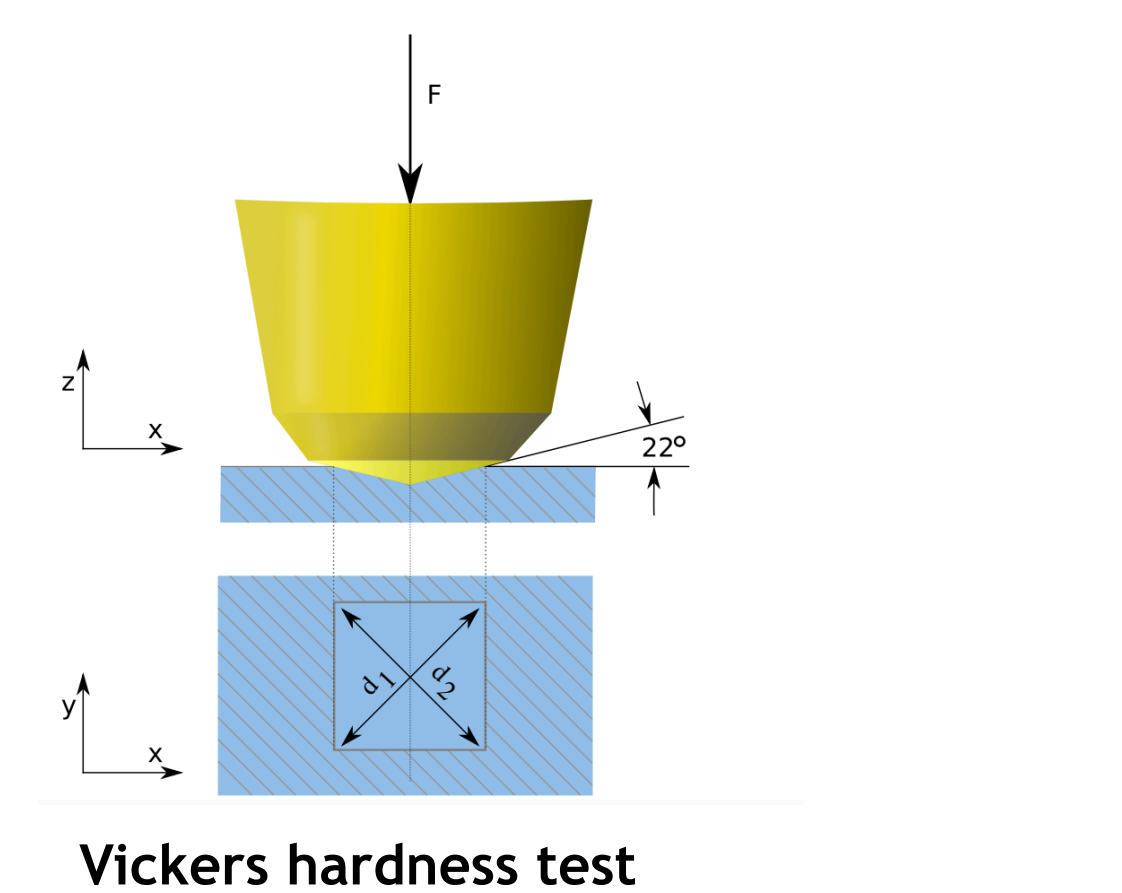
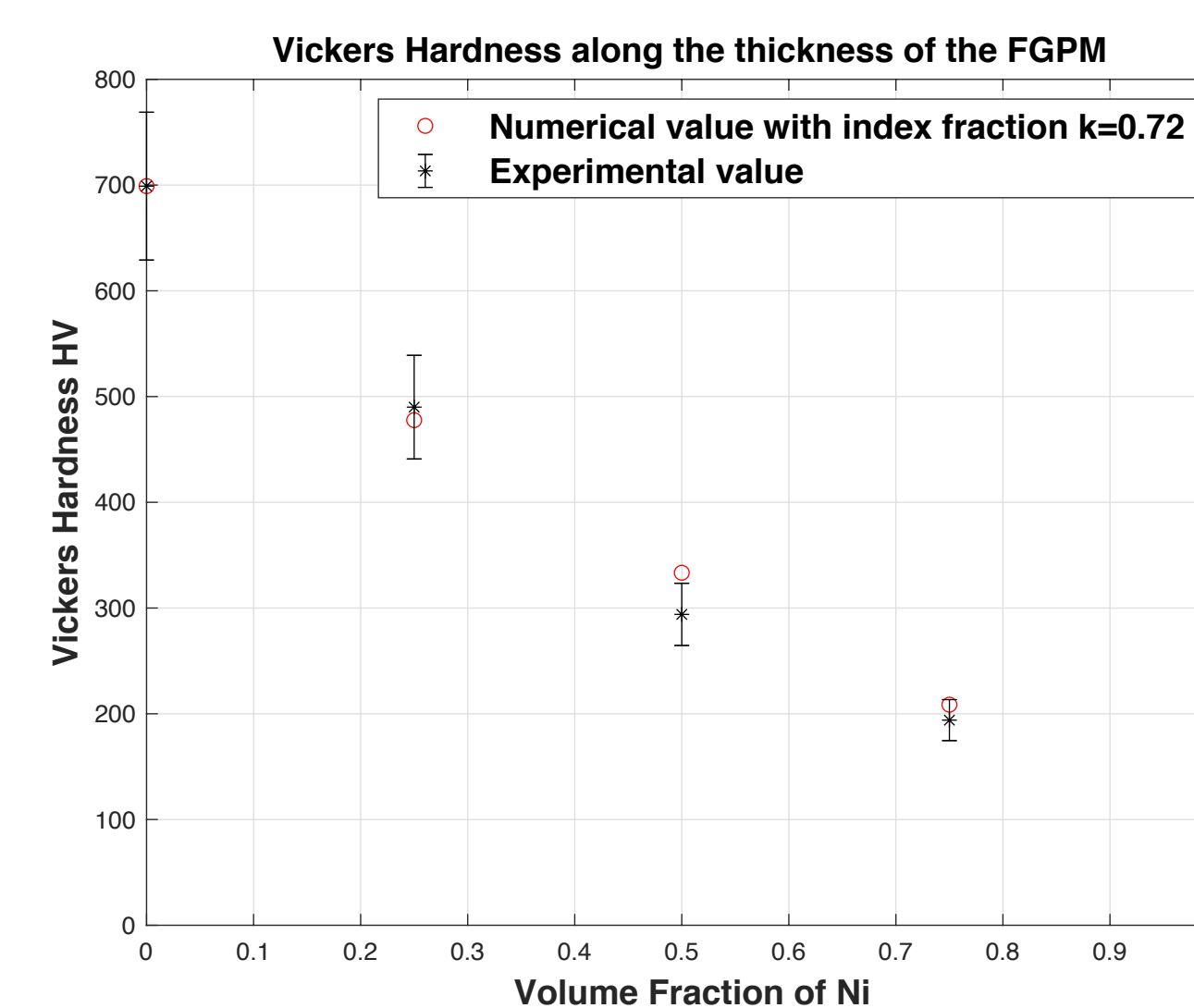
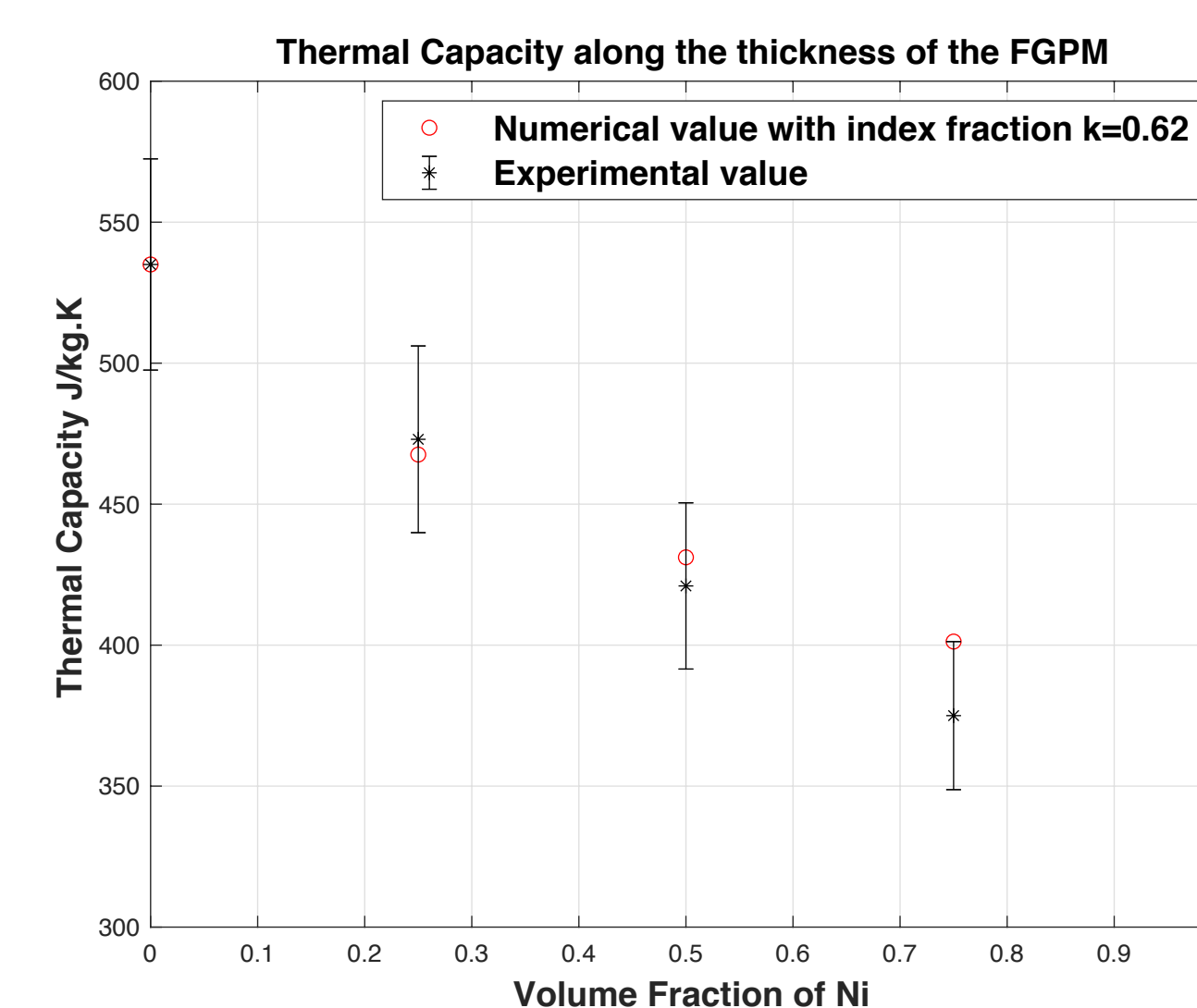
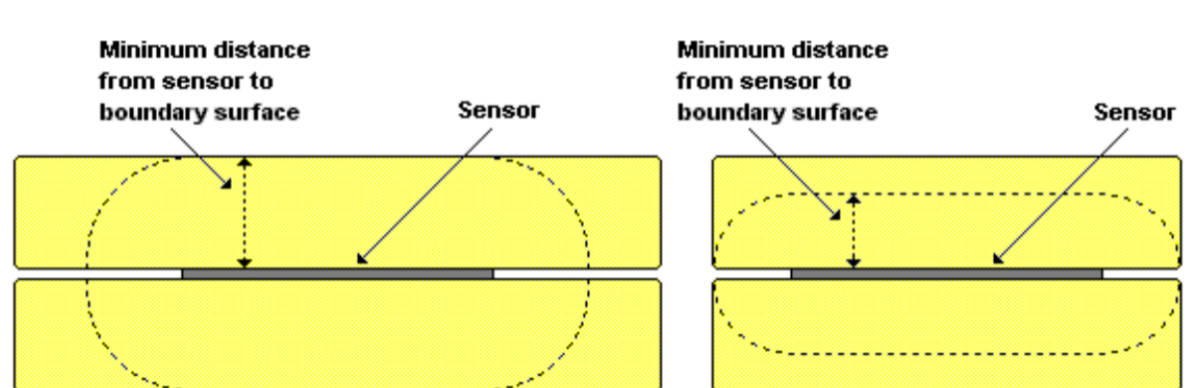
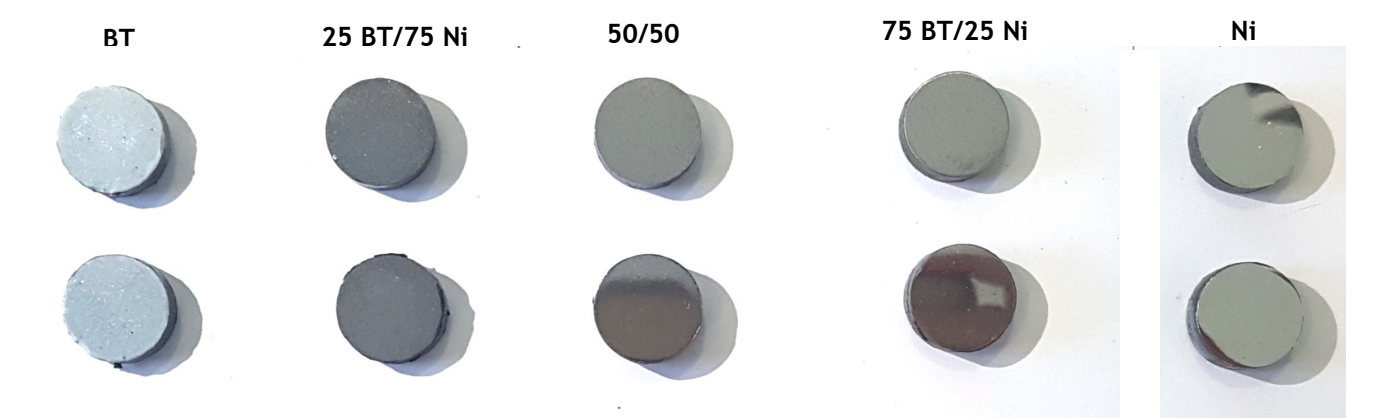
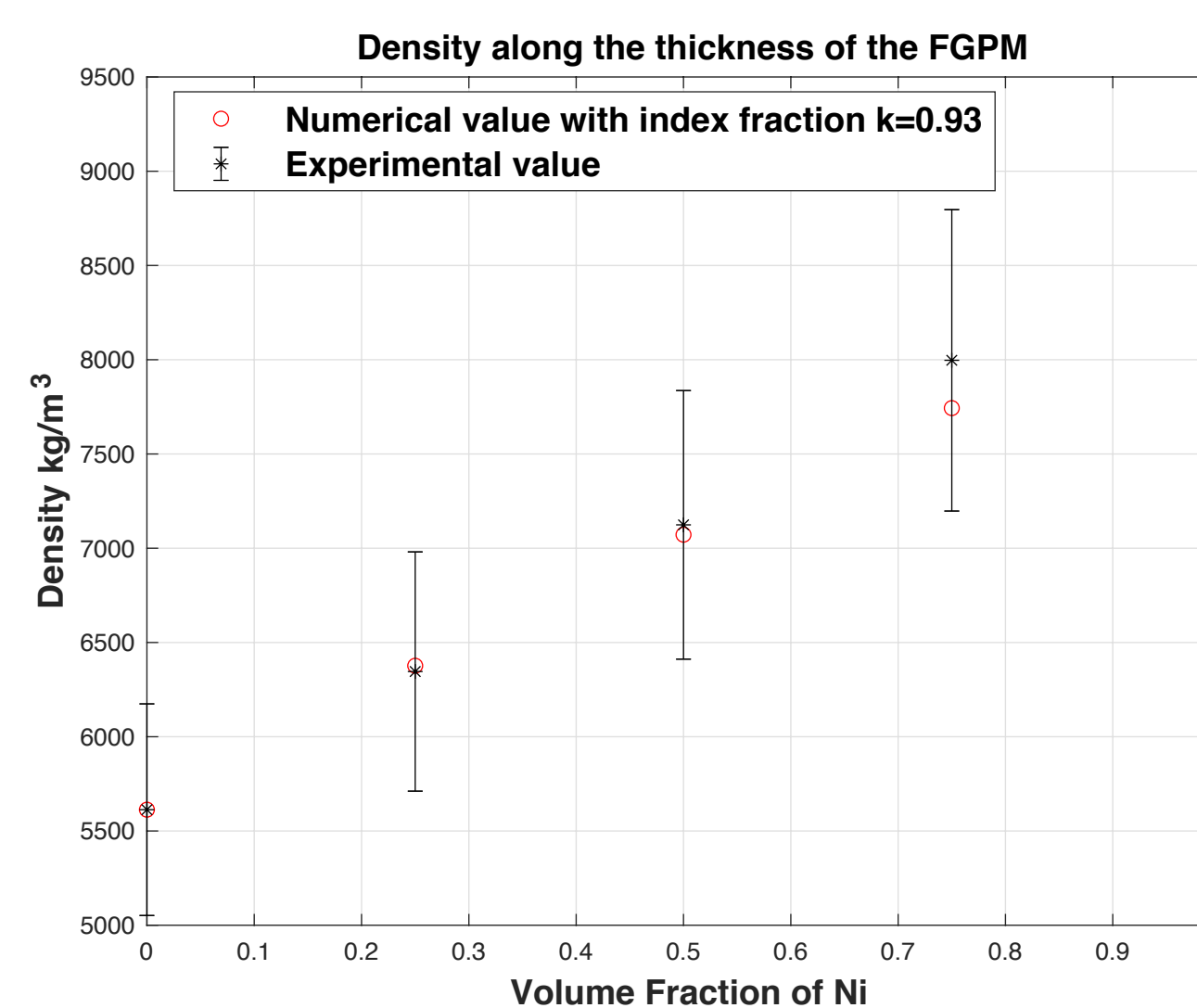
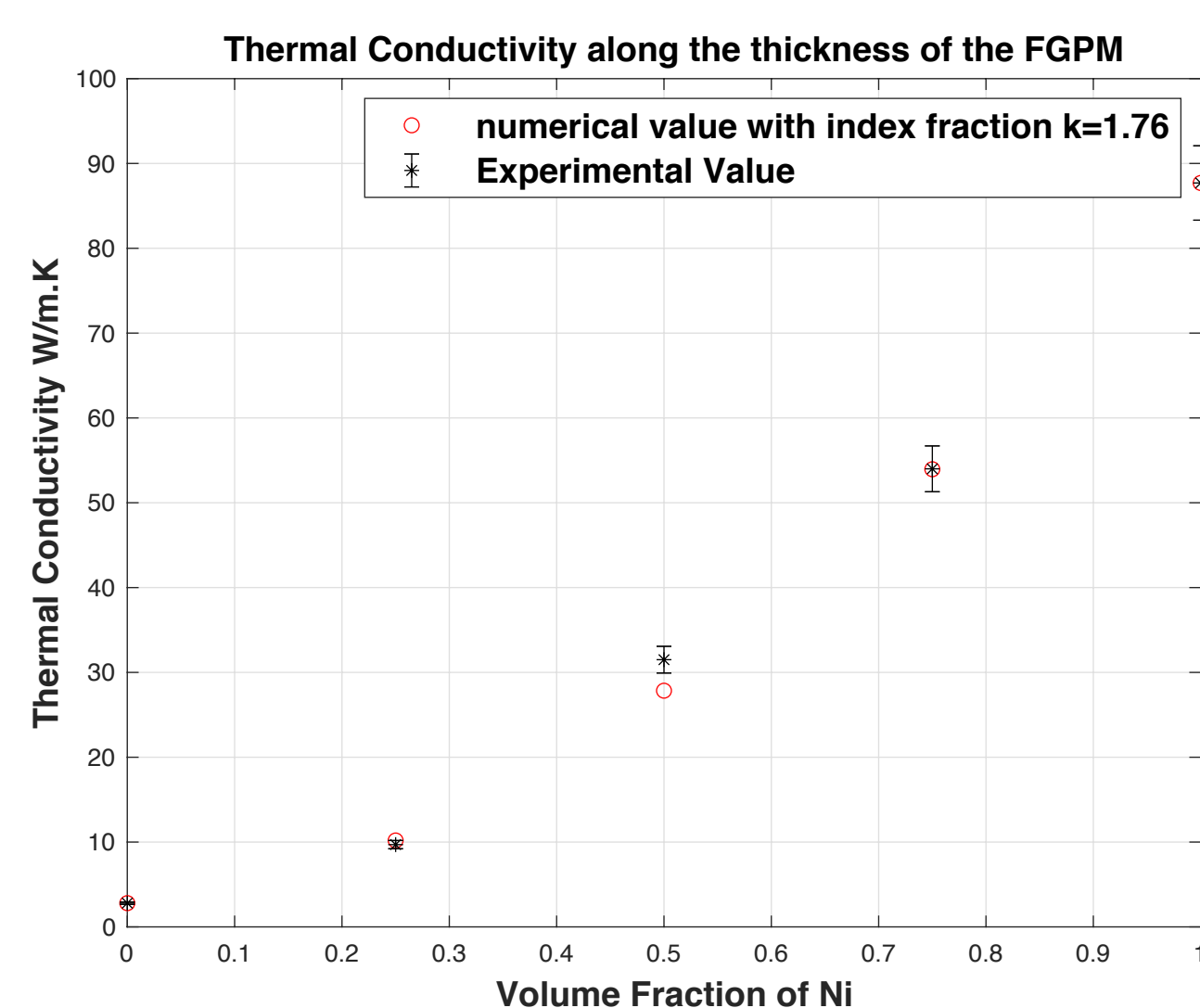
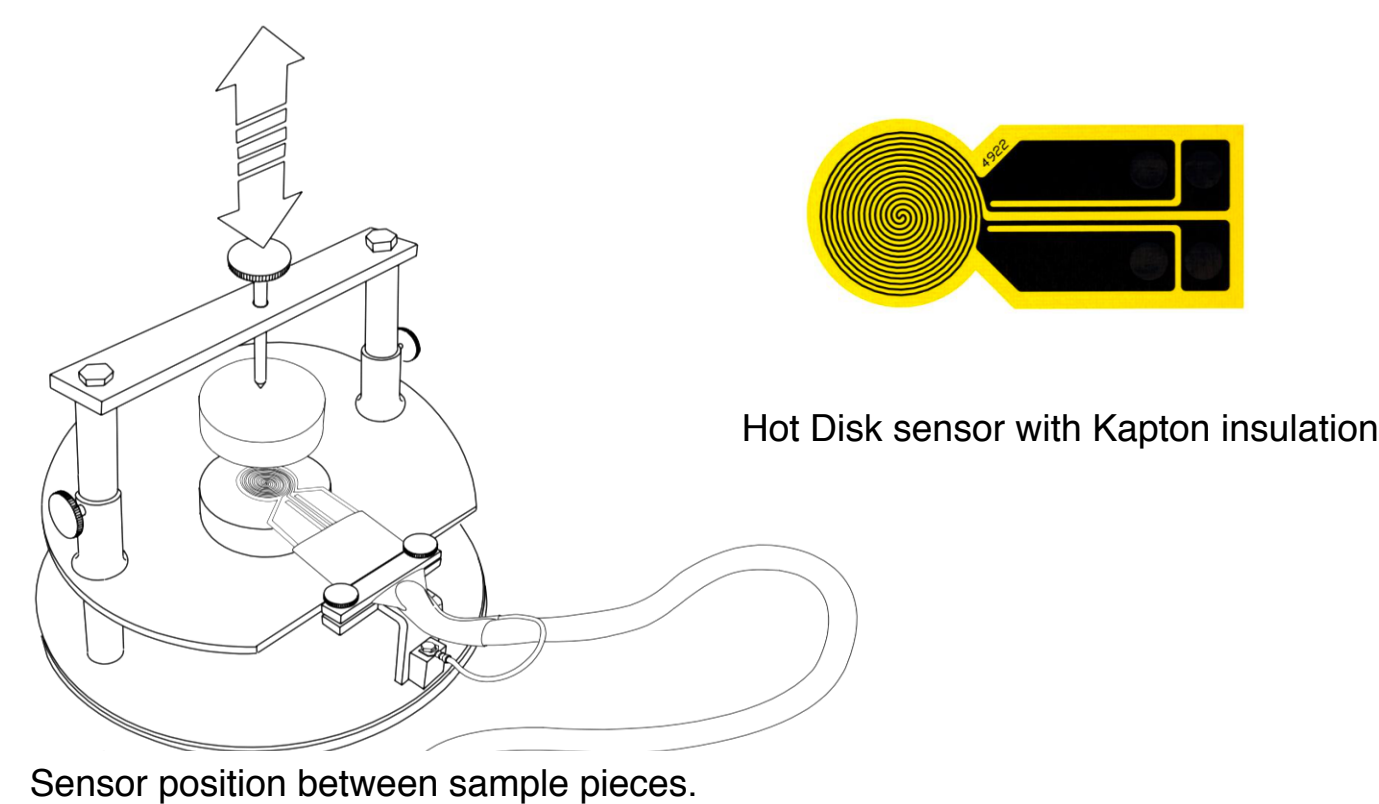

Hardness is a characteristic of a material. It is defined as the resistance to indentation, and it is determined by measuring the permanent imprint surface of a diamond pyramid pressed against the solid with a certain normal load.

The thermal conductivity was measured by the transient plane source (TPS) technique, with a TPS 2500 Hot Disk thermal analyzer (accuracy of around 5%). The sensor is placed between two identical samples.

The first experimental results show on the one hand that the use of equation 1 seems to be adequate, and on the other hand that the fraction index  $k$  is not a constant value and depends on the nature of the measured property  $P$ .

Characterization of the Young's Modulus: as the thickness of FGPM pellet is very low, a compression test is implemented using two very hard and stiff intermediate metallic parts in STUB steel (100Cr6). The pellet is equipped with a small strain gauge (size 5x4 mm<sup>2</sup>). Unfortunately, the first results are not usable because of the difficulty in sticking gauges on tiny specimens. Next tests will be conducted with larger FGPM specimens. Work is in progress...

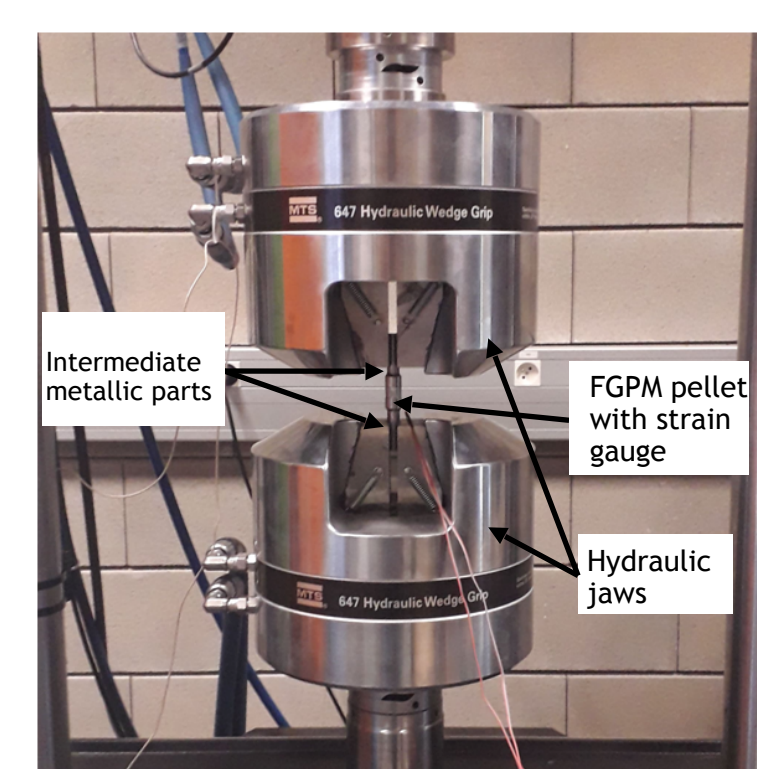

Small strain gauge (size 5x4 mm<sup>2</sup>) on Ni pellet

Compression test using an hydraulic Fatigue Testing System

## Conclusion and perspectives:

The first results show that the coefficient  $k$  is different for each characteristic, it will probably also be different for the mechanical and piezoelectric properties. It will be interesting to study the influence of  $k$  on the quality of active control : Which microstructural parameters are connected to  $k$ ? Can we optimize this coefficient  $k$  at the elaboration stage in order to obtain better active control? Work is in progress !